

EM-VLD-045

VLD - for DC traction / Monitoring for VLD

Control unit of VLD remote monitoring system

Remote monitoring system of VLD

- fully automatic monitoring of VLD class 2
- up to 4 VLD sensors connectable
- local data recording to SD card
- online voltage and current measurement
- forced VLD switch off to reduce stray currents (option)
- integrated web server
- detection of VLD fault
- remote connection to SCADA via MODBUS (TCP/IP)

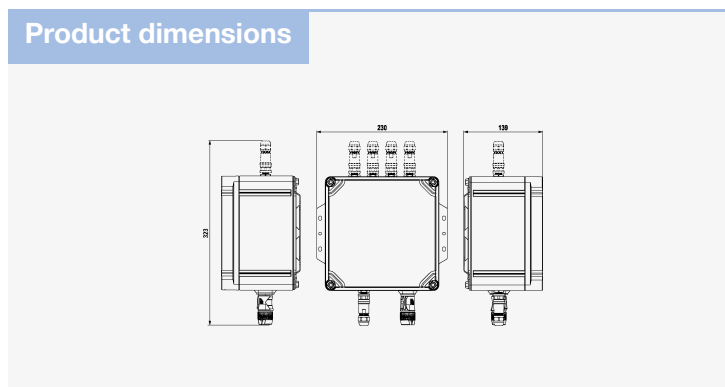

Parameter name	Parameter value
Nominal triggering voltage of VLD	45.00 V DC
Number of connectable measuring units	1 - 4
Rated power supply voltage AC 50 Hz	110 – 230 V ± 10 %
Maximum rated power (in the case of connecting 4 measuring units)	80.00 VA
Remote monitoring (SCADA)	MODBUS using TCP/IP
Connection of measuring units	M12, 8-pin, a-code (S/FTP min. Cat. 6, < 100 m)
Connection to the SCADA system	M12, 8-pin, a-code (S/FTP min. Cat. 6)
Overvoltage category for power circuit	CAT II up to 300 V
Weight	2.30 kg
Location of SPD	indoor and outdoor
Mounting	wall / column / DIN rail 35 mm
Range of ambient temperatures (min/max)	-20 / 50 °C
Degree of protection	IP 65
Altitude	up to 4000 m above sea level

Humidity	20 - 95 %
Pollution degree (IEC 60664-1)	2
Degree of mechanical resistance	IK 08 (5 J)
According to standard	EN 61010-1, IEC 61010-1, EN IEC 61326-1, IEC 61326-1
ETIM Class	EC002495
Customs tariff number	85301000
EAN	8595090574088
Order number	A07408

SALTEK s.r.o., Drážďanská 561/85, 400 07 Ústí nad Labem, CZ | +420 475 655 511 | info@saltek.cz | www.saltek.eu
Technická podpora: 800 818 818 | podpora@saltek.cz

30.06.2026 -
05:52:53